



5750 DONAHUE STREET, MONTREAL, QUEBEC. H4S 1C1

TEL.: 514-336-3820, 800-390-0140 FAX: 514-745-1764







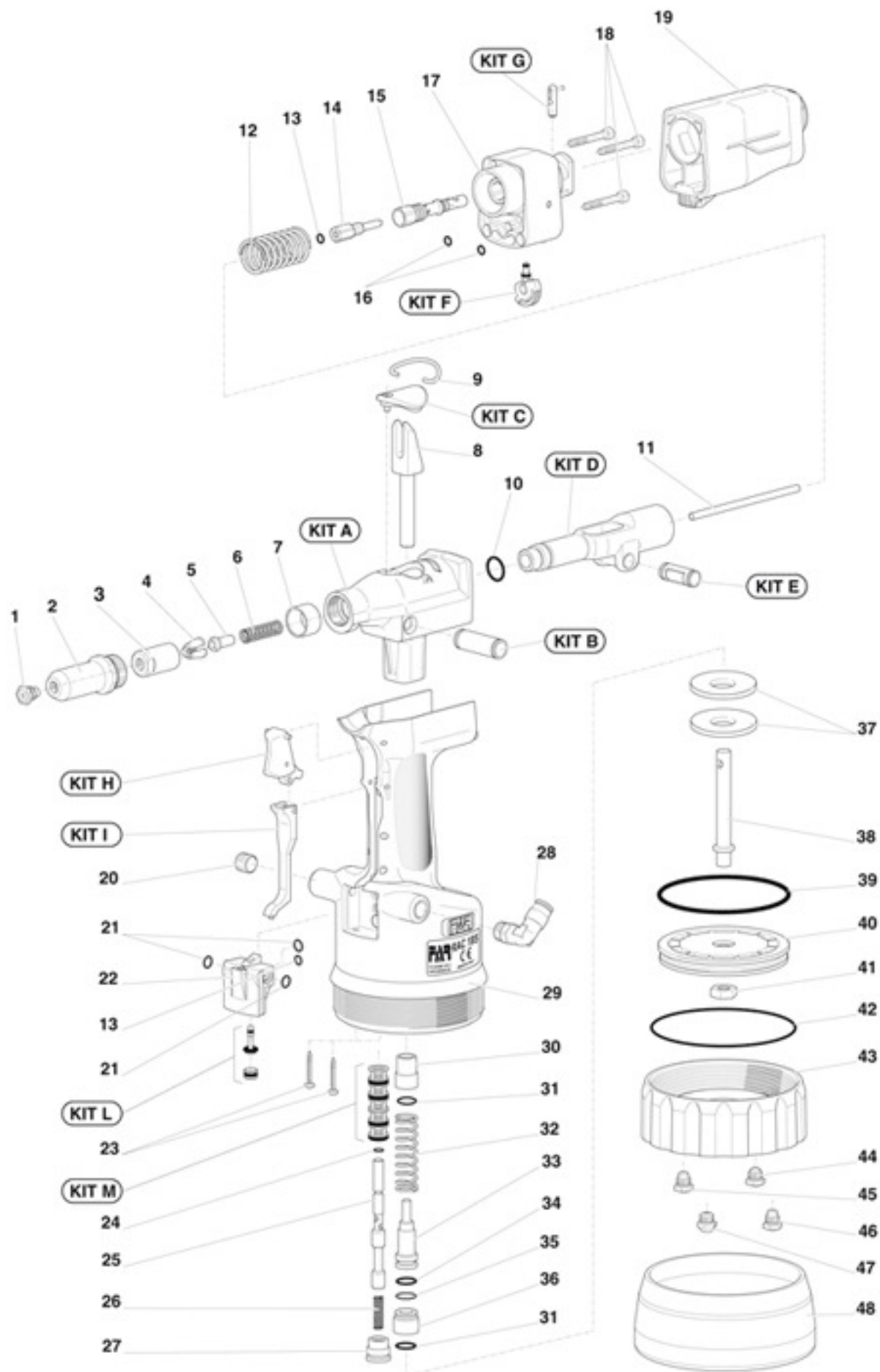

www.airtekltd.com E-MAIL info@airtekltd.com

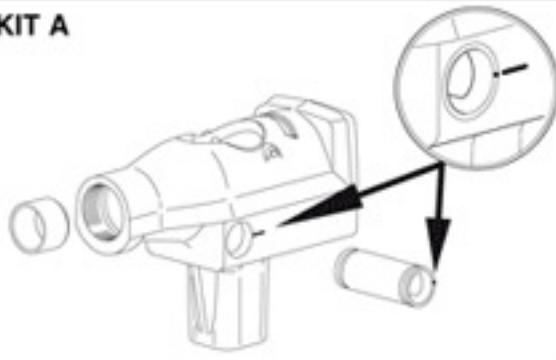
RAC185

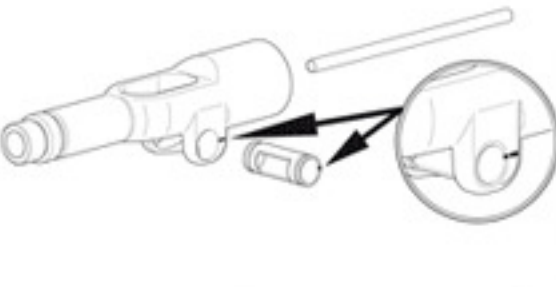
<u>Position</u>	<u>Code</u>	<u>Description</u>	<u>Quantity</u>
1	717003	Nozzle for rivet ø 4,8 All.	1
2	71345871	Sleeve carrying nozzle	1
3	710859	Clamps holding cone	1
4	71345507	High-performance clamps	3
5	710849	Clamps opener	1
6	711158	Spring	1
7	71C00966	Bush GSM 1922-14	1
8	71345858	Wedge	1
9	71345880	Balancer hook	1
10	710102	Gasket OR 113	1
11	71345863	Expeller extension	1
12	71345879	Spring	1
13	710367	Gasket OR 2-008	2
14	71345869	Suction cone	1
15	71345868	Suction body	1
16	712313	Gasket OR 104	2
17	72A00196	Back connector	1
18	71C00546	Screw TCCE M5 x 35 UNI 5931	3
19	72A00200	Nails container	1
20	71C01022	Cap 1/4"	1
21	716060	Gasket OR 2-010	3
22	71345847	Body	1
23	71C01018	Screw TBIC ø 3,9 x 19 UNI 9707	2
24	713390	Gasket OR 2-007	1
25	71345846	Coil	1
26	71345877	Spring	1
27	71345855	Cap	1
28	711067	Connector 6511 - ø 8 - 1/4"	1
29	72B00054	Handgrip	1
30	71345857	Tie rod	1
31	71C01051	Gasket OR 613	2
32	71345905	Spring	1
33	71345859	Piston	1
34	710931	Gasket OR 614	1

<u>Position</u>	<u>Code</u>	<u>Description</u>	<u>Quantity</u>
35	713271	Gasket OR 2-014	1
36	71345865	Steam guide	1
37	711782	Dampener	2
38	71345866	Steam	1
39	713398	Gasket OR 2-340	1
40	71345886	Pneumatic piston	1
41	71C00945	Nut M10 x 1	1
42	71C01019	Gasket OR 155	1
43	71345835	Cover	1
44	717001	Nozzle for rivet \varnothing 2,5 / 3,4	1
45	717002	Nozzle for rivet \varnothing 4	1
46	717004	Nozzle for rivet \varnothing 4,8 Cu/Steel	1
47	717006	Nozzle for rivet \varnothing 2,4	1
48	711736	Protection bottom	1
KIT A	74000061	Head kit	1
KIT B	74000062	Fixed roller kit	1
KIT C	74000056	Cap kit	1
KIT D	74000063	Carriage kit	1
KIT E	74000064	Movable roller Kit	1
KIT F	74000055	Suction obturator kit	1
KIT G	74000054	Valve kit	1
KIT H	74000057	Push-button kit	1
KIT I	74000058	Start lever kit	1
KIT L	74000060	Valve obturator kit	1
KIT M	74000059	Casing kit	1



<p>KIT A</p> 	<p>KIT B</p> 	<p>KIT C</p> 		
<p>KIT D</p> 	<p>KIT E</p> 	<p>KIT F</p> 		
<p>KIT G</p> 	<p>KIT H</p> 	<p>KIT I</p> 	<p>KIT L</p> 	<p>KIT M</p> 